

## CuringPen

### LED Curing Light USER MANUAL

Changzhou Sifary Medical Technology Co.



# Content

<b>1. Scope of CuringPen</b>	<b>4</b>
1.1 Parts Identification	4
1.2 Components and accessories	5
1.3 Optional accessories	5
<b>2. Symbols Used</b>	<b>6</b>
<b>3. Before Use</b>	<b>7</b>
3.1 Scope of application	7
3.2 Contraindications	7
<b>4. Setting up the CuringPen</b>	<b>8</b>
4.1 Install the light source head	8
4.2 Install the disposable sleeve	8
4.3 Install the protective light shield	8
4.4 Charging	9
<b>5. Use Interface</b>	<b>10</b>
5.1 Panel key	10
<b>6. Setting</b>	<b>11</b>
6.1 Selecting memory	11
6.2 Advanced setting	12
<b>7. Operation</b>	<b>13</b>
7.1 Charge	13
7.2 Handpiece operation	14
7.3 Operation mode	16
<b>8. Maintenance</b>	<b>18</b>
<b>9. Error Warning</b>	<b>19</b>
<b>10. Troubleshooting</b>	<b>20</b>
<b>11. Technical Data</b>	<b>21</b>
<b>12. EMC Tables</b>	<b>22</b>
<b>13. Statement</b>	<b>27</b>



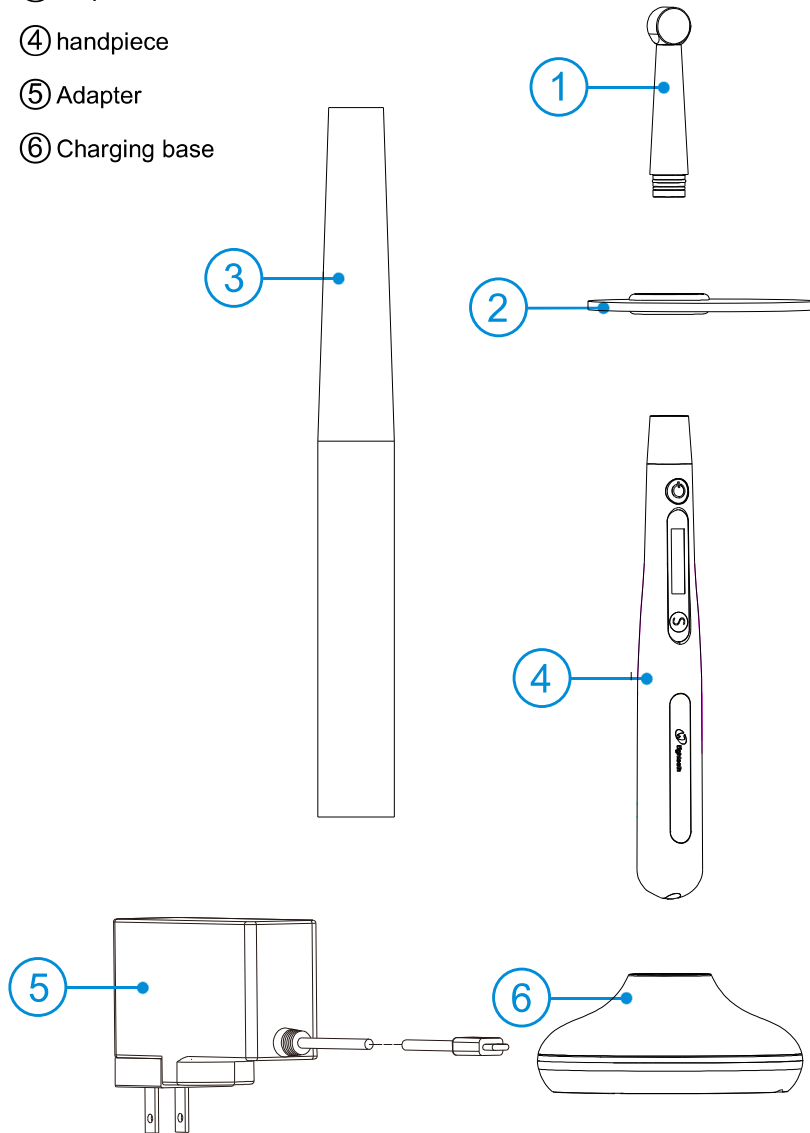

## 1.Scope of CuringPen

### 1.1 Parts Identification



- ① Light source head
- ② Protective light shield
- ③ Disposable sleeve
- ④ handpiece
- ⑤ Adapter
- ⑥ Charging base

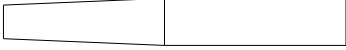
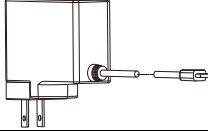

















## 1.2 Components and accessories

<p>Handpiece (1pcs) ORDER CODE:6551003</p> 	<p>Light source head(1pcs) ORDER CODE:6551001</p> 
<p>Disposable sleeve ( 100pcs ) ORDER CODE:6542002</p> 	<p>Adapter (1pcs) ORDER CODE:6516001</p> 
<p>Charging base (1pcs) ORDER CODE:6551004</p> 	<p>Protective light shield (1pcs) ORDER CODE:6551005</p> 

## 1.3 Optional accessories

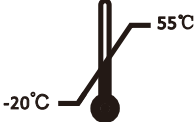
<p>Light curing depth test board (1pcs) ORDER CODE:6503011</p> 	<p>Protective light glasses (1pcs) ORDER CODE:6541001</p> 
--	--

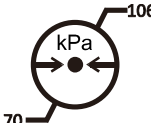
## 2. Symbols Used

 <b>Warning</b>	If the instructions are not followed properly, operation may lead to hazards for the product or the user/patient.
 <b>NOTE</b>	Additional information, explanation of operation and performance.
	Serial number
	Catalogue number
	Manufacturer
	Date of manufacture
	Safety class II device
	Type B applied part
	Direct current
	WEEE(Waste of Electrical and Electronic Equipment )Directive Marking
	Store in a dry place
	Consult instructions for use
	Authorized Representative in the European Community
	Temperature limitation
	Relative humidity
	Transport and storage pressure conditions:70 kPa - 106 kPa
 <b>Eigtheeth</b>	Manufacturer's LOGO

### 3. Before Use

#### 3.1 Scope of application

Suitable for the purpose of curing dental resins and composites or detecting caries.

This device must only be used in hospital environments, clinics or dental offices by qualified dental personnel

#### 3.2 Contraindications

Do not use the device for non-endodontic dental procedures.

Safety and effectiveness have not been established in pregnant women and children.



#### **Warning**

Read the following warnings before use:

1. **The device must not be placed in humid surroundings or anywhere where it can come into contact with any type of liquids.**
2. **Do not expose the device to direct or indirect heat sources. The device must be operated and stored in a safe environment.**
3. **The device requires special precautions with regard to electromagnetic compatibility (EMC) and must be installed and operated in strict compliance with the EMC information. In particular, do not use the device in the vicinity of fluorescent lamps, radio transmitters, remote controls, portable or mobile RF communication devices and do not use this system near the active HF Surgical Equipment in the hospital .Do not charge, operate or store at high temperatures. Comply with the specified operating and storage conditions.**
4. **Protective light shield and a disposable sleeve are compulsory during treatment.**
5. **If irregularities occur in the device during treatment, switch it off. Contact the agency.**
6. **Never open or repair the device yourself, otherwise, void the warranty**

## 4. Setting up the CuringPen

### 4.1 Install the light source head

Make sure the light source head alignment the slots of handpiece, plug them together until it "click" securely into place.

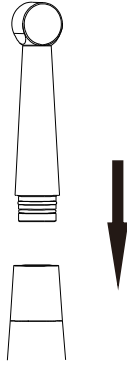

The light source head can be 360 degrees rotated without take off, make it easy to watch the LCD in treatment



#### **WARNING**

- After connecting the light source head and the handpiece, pull it gently to make sure the connection is good.
- Make sure the assembly is connected properly, otherwise might cause unexpected fault, even hurt the patients

### 4.2 Install the disposable sleeve

Take a disposable sleeve and gently insert it into the handpiece from the light source head.

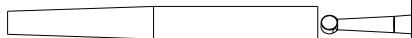

### 4.3 Install the protective light shield

Make sure the light source head alignment the slots of the protective light shield, plug them together.

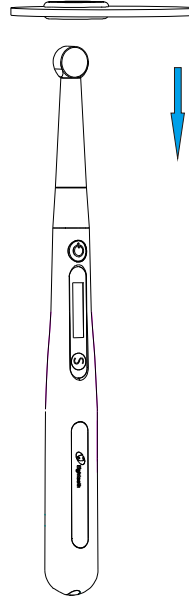

#### **WARNING**

- Disposable sleeve must be discarded after use
- The light source head, protective light shield and handpiece should be cleaned and disinfected after each treatment.

Avoid direct exposure of the lamp to the eyes during working



#### 4.4 Charging

Plug the USB of adapter into the charge base, and plug the other end into a power outlet, the Power LED on charge base will light up (green).

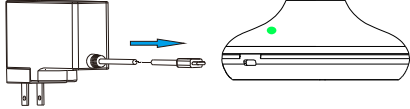

#### NOTE

- Only the original adapter could be used.

Put the handpiece all the way into the charge base, the charge state will show on the screen.

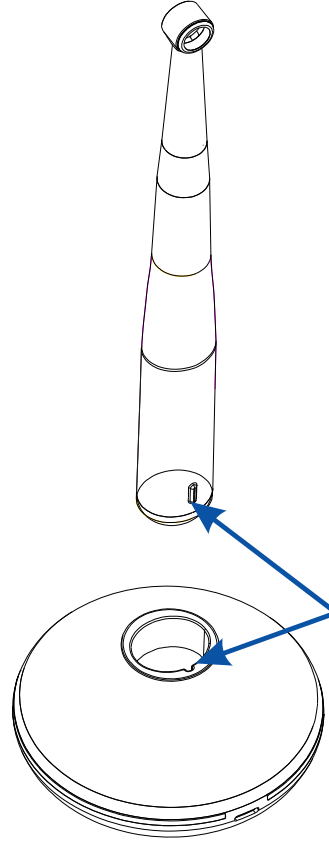

Charging indication appears on the screen, and flashes slowly, when battery is fully charged or in a state near full charge, the flash will stop







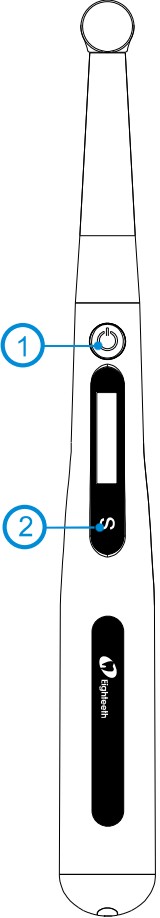

#### NOTE

- Put the handpiece into the charge base in the right direction, otherwise the handpiece will not be recharged.



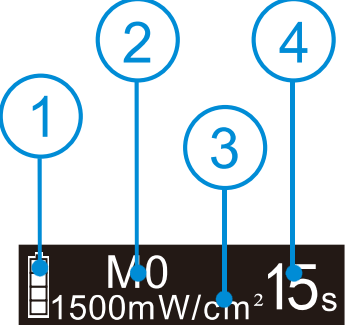

## 5.Use Interface

### 5.1 Panel key





	<p>①  main switch</p> <p>② “S” Setting key</p> <p><b>Turn Power On</b> Press  more than 0.5 seconds to turn on the instrument</p> <p><b>Memory Change</b> Press setting key during standby state</p> <p><b>Turn Power Off</b> Long press  to turn power off.</p> <p><b>Advanced setting</b> During power off state, holding down press “S” then press  to entry advanced setting, Press “S” till target setting, press  to adjust, then press “S” to confirm</p>
	<p>① Battery</p> <p>② Memory</p> <p>③ Curing light intensity</p> <p>④ Curing time</p>

## 6.Setting

### 6.1 Selecting memory





	<p><b>Memory Change</b></p> <p>There are 6 built-in memory programs, namely M0, M1, M2, RAMP, PULSE, Detect. Press setting key to change the memory during standby state</p>										
	<p><b>Light intensity setting</b></p> <p>The memory programs of M0, M1 and M2 can be customized to 2300mW/cm<sup>2</sup>, 1500mW/cm<sup>2</sup> or 1000mW/cm<sup>2</sup>. Long Press “S” to enter the light intensity setting menu, then press “S” to change or press main switch to confirm and exit.</p> <p>On the light intensity setting menu, long press “S” to enter the time setting menu.</p> <div style="background-color: #e0e0e0; padding: 10px; margin-top: 10px;"> <p> <b>NOTE</b></p> <ul style="list-style-type: none"> <li>● <b>The light intensity of RAMP, PULSE and Detect memory programs are built-in, and the user cannot modify the settings.</b></li> </ul> </div>										
	<p><b>Curing Time setting</b></p> <p>In the curing time setting menu, press “S” to select different times. The time selection is different under different light intensity:</p> <table border="1" data-bbox="657 1191 1235 1379"> <thead> <tr> <th>light intensity(mW/cm<sup>2</sup>)</th> <th>time selection(sec)</th> </tr> </thead> <tbody> <tr> <td>2300</td> <td>01,02,03</td> </tr> <tr> <td>1500</td> <td>05,10,15,20</td> </tr> <tr> <td>1000</td> <td>05,10,15,20</td> </tr> <tr> <td>600</td> <td>10,15,20,25</td> </tr> </tbody> </table> <p>Long press “S” or short press to exit the setting.</p> <p>The current memory program automatically saves the setting parameters.</p>	light intensity(mW/cm <sup>2</sup> )	time selection(sec)	2300	01,02,03	1500	05,10,15,20	1000	05,10,15,20	600	10,15,20,25
light intensity(mW/cm <sup>2</sup> )	time selection(sec)										
2300	01,02,03										
1500	05,10,15,20										
1000	05,10,15,20										
600	10,15,20,25										

**6.2 Advanced setting**

<p style="text-align: center;">Auto Off 5 min</p>	<p>During power off state, holding down press “S” then press  to entry the “Auto power off time” setting.</p> <p>It can be set to 1min, 5min, 10min or 15min.</p> <p>Press  to change setting, press “S” to enter the next setting “Volume” volume setting mode.</p>
<p style="text-align: center;">Volume mid</p>	<p>In the volume setting menu, press “S” to select different settings. It can be set to “Off”, “low”, “mid” or “high”.</p> <p>Press  to change setting, press “S” to enter the next setting “Hand” hand setting mode.</p>
<p style="text-align: center;">Hand Right</p>	<p>The right hand and the left hand can be set in the “Hand” setting menu, Press  to change setting, press “S” to enter the next setting.</p>
<p style="text-align: center;">L1</p>	<p>The last item is the firmware version, and the handpiece shuts down automatically within 30s after the version information is displayed.</p>

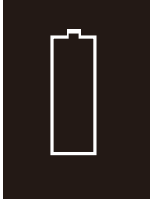
## 7.Operation

### 7.1 Charge

	<p>Displays the present remaining amount of the battery.</p> <p>Less than 15% remains, please charge.</p> <div style="background-color: #e0e0e0; padding: 5px;">  <b>NOTE</b> <ul style="list-style-type: none"> <li>● <b>If the power is less than 15%, must be recharged within 30 days, otherwise the battery will be damaged.</b></li> </ul> </div>
	<p>Charging indication appears on the screen, and flashes slowly, when battery is fully charged or in a state near full charge, the flash will stop. Fully charged will take about 4 hours, depending on residual battery power and battery state.</p> <p>It can be recharged 300-500 times, depending on the operating conditions of the device.</p> <div style="background-color: #e0e0e0; padding: 5px;">  <b>NOTE</b> <ul style="list-style-type: none"> <li>● <b>When charging, other function will forcibly stop, take from charge base, press main switch, the last function will recall.</b></li> </ul> </div>
<div style="background-color: #e0e0e0; padding: 10px;">  <b>WARNING</b> <ul style="list-style-type: none"> <li>● <b>Do not change the battery, only trained technician or distributor can change the battery, the electronic parts will be damaged if use a wrong battery or install with a wrong way.</b></li> </ul> </div>	

## 7.2 Handpiece operation

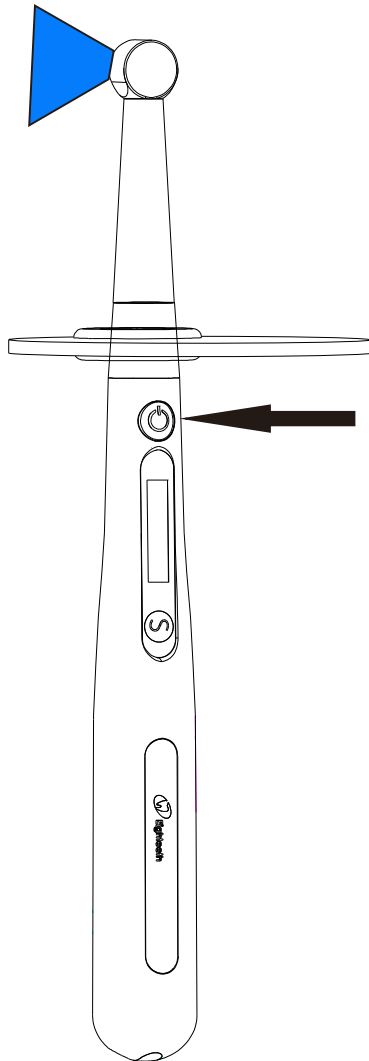

After the handpiece main unit is turned on, press  to start the light intensity output, and the time will start counting down. Press any key to interrupt the output during the light intensity output.

There is a beep every 5s while working, and the output is automatically turned off after the countdown ends.





### **WARNING**

- When the device is working, do not directly illuminate the eyes, otherwise it will cause injury.
- Do not directly illuminate the skin, otherwise high temperature burns may occur.





### **NOTE**



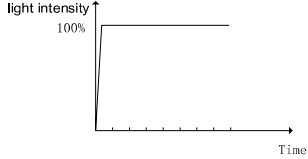

- After the device is used continuously for 10 times at  $2300\text{mW}/\text{cm}^2$ , it will be prohibited to use the highest light intensity output within 1 minute, Used to prevent the lamp from overheating
- When using, the light should be directly irradiated onto the curing dental resins and composites to avoid improper exposure.
- The disposable

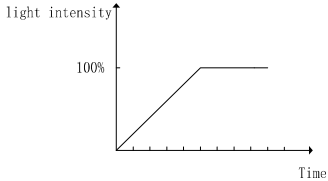
	<p><b>protective cover and protective light shield are highly recommended.</b></p>
	<p>When the device is in standby mode, it will automatically shut down when it reaches the set time. The factory default setting is 5 minutes</p>
<p> <b>WARNING</b></p> <ul style="list-style-type: none"><li>● Before using, please try it outside the oral cavity to ensure that there is no problem with the function of the device.</li><li>● Do not disassemble the lamp during treatment .</li></ul>	
<p> <b>NOTE</b></p> <ul style="list-style-type: none"><li>● If there is any abnormal functioning, stop using the device and report to company</li><li>● Gloves are compulsory during treatment</li><li>● Always clean the handpiece and light source head after each treatment.</li></ul>	



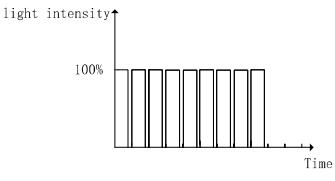
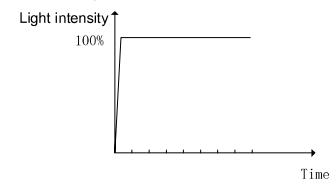



## 7.3 Operation mode

<b>M0、M1、M2</b>	<p><b>Standard mode</b></p> <p>In these three modes, the light intensity can be set to 2300mW/cm<sup>2</sup>, 1500mW/cm<sup>2</sup> or 1000mW/cm<sup>2</sup>.</p> <p>Wavelength: 385nm-515nm</p> <p>When  pressed, the setting light intensity is output immediately, and the sound is prompted every 5 seconds.</p> 
<b>RAMP</b>	<p><b>Ramp Mode</b></p> <p>Light intensity : 1000mW/cm<sup>2</sup>.</p> <p>Wavelength: 385nm-515nm</p> <p>When  pressed, the light intensity gradually increases to 1000mW/cm<sup>2</sup> in the first 5 seconds, and then continues to output 1000mW/cm<sup>2</sup>, prompting the sound every 5 seconds.</p> 
<b>PULSE</b>	<p><b>Pulse Mode</b></p> <p>Light intensity : 1000mW/cm<sup>2</sup></p> <p>Wavelength: 385nm-515nm</p>

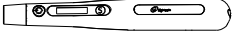

	<p>When  pressed, the output light intensity is 1000mW/cm<sup>2</sup> and flashes once every 1 second, prompting the sound every 5 seconds.</p> 
<h2>Detect</h2>	<p><b>Detecting mode</b></p> <p>Light intensity : 600mW/cm<sup>2</sup> Wavelength: 385nm-410nm</p>  <p>When  pressed, the setting light intensity is output immediately, and the sound is prompted every 5 seconds.</p> <div style="background-color: #cccccc; padding: 10px;"> <p> <b>NOTE</b></p> <ul style="list-style-type: none"> <li>• This mode is only suitable for detecting dental calculus, caries, cracks, etc.</li> </ul> <p> <b>WARNING</b></p> <ul style="list-style-type: none"> <li>• Detect Mode cannot be used to cure dental resins and composites, otherwise there is a risk of incomplete curing.</li> </ul> </div>

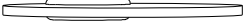
## 8.Maintenance

Disinfection components		
handpiece 	Light source head 	Adapter 
Charging base 	Protective light shield 	
Wipe all the surfaces with a cloth lightly moistened with Ethanol for Disinfection (Ethanol 70 to 80vol%) at least 2min, repeat for 5 times.		
<div style="background-color: #f0f0f0; padding: 10px;">  <p><b>WARNING</b></p> <ul style="list-style-type: none"> <li>Do not use anything except Ethanol for Disinfection (Ethanol 70 to 80 vol%).</li> <li>Do not use too much ethanol as it's going into machine and damage the components inside.</li> </ul> </div>		

Disposable components
Disposable sleeve ( 100pcs ) 
<div style="background-color: #f0f0f0; padding: 10px;">  <p><b>WARNING</b></p> <ul style="list-style-type: none"> <li>Please discard it after use and do not use it again.</li> <li>The product has been disinfected with ethylene oxide, so there is no need to disinfect it before use.</li> </ul> </div>

## 9.Error Warning

<p style="text-align: center;"><b>Low Battery</b></p>	<p>The battery is too low. Charge it immediately</p>
<p style="text-align: center;"><b>Fault: Blue Error</b></p>	<p>Blue LED broken, contact your distributor.</p>
<p style="text-align: center;"><b>Fault: Blue Overload</b></p>	<p>Blue LED overload, contact your distributor.</p>
<p style="text-align: center;"><b>Fault: Violet Error</b></p>	<p>Violet LED broken, contact your distributor.</p>
<p style="text-align: center;"><b>Fault: Violet Overload</b></p>	<p>Violet LED overload, contact your distributor.</p>
<p style="text-align: center;"></p>	<p>The temperature of the light source head is higher than expectation, turn the power off or waiting more than 1 minutes to let it cold down.</p>

## 10. Troubleshooting

When trouble is found, check the following points before contacting your distributor. If none of these are applicable or the trouble is not remedied even after action has been taken, the product may have failed. Contact your distributor.

Problem	Cause	Solution	Ref · ch ap
The power is not turned on.	The battery is run down.	Charge the battery.	7.1
	The time to press the main switch is too short.	Press the main switch more than 0.5 seconds.	5.1
The Power LED does not light up when charging.	Use a wrong adapter.	Use the original adapter.	/
	There is no electricity in the outlet.	Check the connection.	/
	The adapter is not connected.	Check the connection.	/
the handpiece does not display the charging interface while charging	Put the handpiece into the charge base in the wrong direction.	Check the direction.	4.4
	The charge base broken.	Using adapter connect to handpiece directly, and contact your distributor.	/
	Charge pin of charge base unable to rebound.	Remove debris which between move part and base of the charge pin.	/
No output	Handpiece broken	Contact your distributor	/
No sound	Beep volume set to off	Set beep volume to low, mid or high.	/
	Handpiece broken	Contact your distributor	
Insufficient light intensity	There are resin or other contaminants on the surface of the lamp lens	Cleaning the lamp head residue	

**11. Technical Data**

Manufacturer	Changzhou Sifary Medical Technology Co.,Ltd
Model	CuringPen
Dimensions	22cm x 11cmx 8cm±1cm
Weight	730g ±10%
Power supply	Lithium ion battery: 3.7V, 1600mAh, ±10%
Charger power supply	AC 100-240 V, ±10%
Charger power output	5V  1A
Power Frequency	50/60Hz, ±10%
Charger nominal power input	5VA
Light intensity	2300mW/cm <sup>2</sup> 1500mW/cm <sup>2</sup> 1000mW/cm <sup>2</sup> 600 mW/cm <sup>2</sup>
Wavelength	385nm-515nm
Electrical safety class	Class II
Applied part	B
Operation conditions	Use: in enclosed spaces Ambient temperature: 5°C ~ 40 °C Relative humidity: <80% Operating altitude < 3000m above sea level Atmospheric pressure: 70kPa ~ 106kPa
Transport and storage conditions	Ambient temperature: -20 °C ~ +55 °C Relative humidity: 20% ~ 80 % Atmospheric pressure: 70kPa ~ 106kPa

## 12.EMC Tables

<b>Guidance and manufacturer's declaration – electromagnetic emissions</b>		
The <b>CuringPen</b> is intended for use in the electromagnetic environment specified below. The customer or the user of the <b>CuringPen</b> should assure that it is used in such an environment.		
<b>Emissions test</b>	<b>Compliance</b>	<b>Electromagnetic environment-guidance</b>
RF emissions CISPR 11	Group 1	The <b>CuringPen</b> uses RF energy only for its internal function. Therefore, its RF emissions are very low and are not likely to cause any interference in nearby electronic equipment.
RF emissions CISPR 11	Class B	The <b>CuringPen</b> is suitable for use in all establishments, including domestic establishments and those directly connected to the public low-voltage power supply network that supplies buildings used for domestic purposes.
Harmonic emissions IEC61000-3-2	Class A	
Voltage fluctuations/flicker emissions IEC 61000-3-3	Complies	

<b>Guidance and manufacturer's declaration – electromagnetic immunity</b>			
The <b>CuringPen</b> is intended for use in the electromagnetic environment specified below. The customer or the user of the <b>CuringPen</b> should assure that it is used in such an environment.			
<b>Immunity test</b>	<b>IEC 60601 test level</b>	<b>Compliance level</b>	<b>Electromagnetic environment – guidance</b>
Electrostatic discharge (ESD) IEC 61000-4-2	+/- 8 kV contact  +/- 2 kV, +/- 4 kV, +/- 8 kV, +/- 15 kV air	+/- 8 kV contact  +/- 2 kV, +/- 4 kV, +/- 8 kV, +/- 15 kV air	Floors should be wood, concrete or ceramic tile. If floors are covered with synthetic material, the relative humidity should be at least 30 %.

Electrical fast Transients /bursts IEC 61000-4-4	±2kV 100kHz repetition frequency	±2kV 100kHz repetition frequency	Mains power quality should be that of a typical commercial or hospital environment.
Surge IEC 61000-4-5	Line to line: ±0.5kV, ±1kV  Line to earth: ±0.5kV, ±1kV, ±2kV	Line to line: ±0.5kV, ±1kV  Line to earth: ±0.5kV, ±1kV, ±2kV	Mains power quality should be that of a typical commercial or hospital environment.
Voltage dips, short interruptions and voltage variations on power supply lines IEC 61000-4-11	0% UT; 0.5 cycle at 0°, 45°, 90°, 135°, 180°, 225°, 270°, and 315°  0% UT; 1 cycle and 70% UT; 25/30 cycles sine phase at 0°  0% UT; 250/300 cycle	0% UT; 0.5 cycle at 0°, 45°, 90°, 135°, 180°, 225°, 270°, and 315°  0% UT; 1 cycle and 70% UT; 25/30 cycles sine phase at 0°  0% UT; 250/300 cycle	Mains power quality should be that of a typical commercial or hospital environment. If the user of devices require continued operation during power mains interruptions, it is recommended that devices be powered form an uninterruptible power supply or a battery
Power frequency magnetic field IEC 61000-4-8	30 A/m 50Hz or 60Hz	30 A/m 50Hz or 60Hz	Power frequency magnetic field should be at levels characteristic of a typical location in a typical commercial or hospital environment.

Note: UT: rated voltage(s); E.g. 25/30 cycles means 25 cycles at 50Hz or 30 cycles at 60Hz

### Guidance and manufacturer's declaration – electromagnetic immunity

The **CuringPen** is intended for use in the electromagnetic environment specified below. The customer or the user of the **CuringPen** should assure that it is used in such an environment.

Immunity test	IEC 60601 test level	Compliance level	Electromagnetic environment - guidance
Conducted disturbances induced by RF fields IEC 61000-4-6	3 V 0.15 MHz – 80 MHz, 6 V in ISM bands between 0.15 MHz and 80 MHz, 80 % AM at 1 kHz	3 V	Portable and mobile RF communications equipment should be used no closer to any part of the <b>CuringPen</b> , including cables, than the recommended separation distance calculated from the equation applicable to the frequency of the transmitter.  <b>Recommended minimum separation distances</b> See the RF wireless communication equipment table in "Recommended minimum separation distances"
Radiated RF EM fields IEC 61000-4-3	3 V/m, 80 MHz – 2,7 GHz, 80 % AM at 1 kHz	3V/m	
Proximity fields from RF wireless communication equipment IEC 61000-4-3	See the RF wireless communication equipment table in "Recommended minimum separation distances"	Complies	



### Recommended minimum separation distances

Nowadays, many RF wireless equipments have being used in various healthcare locations where medical equipment and/or systems are used. When they are used in close proximity to medical equipment and/or systems, the medical equipment and/or systems' basic safety and essential performance may be affected. The **CuringPen** has been tested with the immunity test level in the below table and meet the related requirements of IEC 60601-1-2:2014. The customer and/or user should help keep a minimum distance between RF wireless communications equipments and the **CuringPen** as recommended below.

Test frequency (MHz)	Band (MHz)	Service	Modulation	Maximum power (W)	Distance (m)	Immunity test level (V/m)
385	380-390	TETRA 400	Pulse modulation 18Hz	1.8	0.3	27
450	430-470	GMRS 460 FRS 460	FM $\pm 5$ kHz deviation 1 kHz sine	2	0.3	28
710	704-787	LTE Band 13, 17	Pulse modulation 217Hz	0.2	0.3	9
745						
780						
810	800-960	GSM 800/900, TETRA 800, iDEN 820, CDMA 850, LTE Band 5	Pulse modulation 18Hz	2	0.3	28
870						
930						
1720	1700-1990	GSM 1800; CDMA 1900; GSM 1900; DECT; LTE Band 1, 3,	Pulse modulation 217Hz	2	0.3	28
1845						
1970						

		4, 25; UMTS				
2450	2400- 2570	Bluetooth, WLAN, 802.11 b/g/n, RFID 2450, LTE Band 7	Pulse modulation 217Hz	2	0.3	28
5240	5100- 5800	WLAN 802.11 a/n	Pulse modulation 217Hz	0.2	0.3	9
5500						
5785						

## 13.Statement

**Service Life**

The service life of CuringPen series products is 3 years.

**Disposal**

The package should be recycled. Metal parts of the device are disposed as scrap metal. Synthetic materials, electrical components, and printed circuit boards are disposed as electrical scrap. The lithium batteries are disposed as special refuse. Please deal with them according to the local environmental protection laws and regulation.

**Rights**

All rights of modifying the product are reserved to the manufacturer without further notice. The pictures are only for reference. The final interpretation rights belong to CHANGZHOU SIFARY MEDICAL TECHNOLOGY CO., LTD. The industrial design, inner structure, etc, have claimed for several patents by SIFARY, any copy or fake product must take legal responsibilities.



**Changzhou Sifary Medcial Technology Co., Ltd**  
Add: NO.99, Qingyang Road, Xuejia County, Xinbei District,  
Changzhou City, 213000 Jiangsu, China  
Tel: +86-0519-85962691  
Fax: +86-0519-85962691  
Email: ivy@sifary.com  
Web: www.sifary.com

Version: S01  
IFU-6535001  
Issued: 2019.9.17  
All rights reserved.